

# DP BIG

filter housings  
for BIG cartridges

Brand new range of Mono, Duo and Trio filter housings designed to fit "BIG" filter cartridges with outer diameter (OD) 4.50", inner diameter (ID) 1.10", height at 10" and 20"

# HOUSINGS DP BIG

FOR CARTRIDGES BIG SX

## Mono, Duo and Trio patented and registered models.

The all new, most comprehensive range of housings fit to 10" and 20" BIG filter cartridges with outer diameter 4,50", with standard SX (DOE) configuration.

A wide range of BIG filter cartridges melt-blown polypropylene, string wound, carbon block and brand new pleated media is available for the housing range.

DP BIG models are available as:

- **CLEAR housings** 10" and 20", with female in/out connections at 1" and 1 1/2" with BSP or NPT threads.
- **BLUE housings** 10" and 20", with female in/out connections at 1" and 1 1/2" with BSP or NPT threads.

All housings, clear and opaque, are also available as models with manometers and with discharge valve provided with drain funnel to protect drinking water from pollution by back-wash, in compliance with **UNI EN 1717-11/2002**.



**SX** cartridges  
with standard flat seals.

### ACCESSORIES INCLUDED



-DP BIG- spanner CODE RB7403019

### CERTIFICATIONS



Housings certified by IAPMO RT to NSF/ANSI 42, 61, 372 - lead free, CSA B483.1. In compliance with Drinking Water Treatment Units regulations, USA and Canada.



Housings are tested and certified under the most stringent procedures worldwide, in compliance with DM 25 (Italy), with the sanitary certification EAC/Ghostreghistracia (Russia) and WaterMark (Australia).

### SYMBOLS LEGEND



For domestic use



For technical and industrial use



Filter housings made in PET, a highly recyclable plastic, are manufactured with a proprietary procedure saving up to 60% of energy in injection molding compared with standard plastics. That is one of Atlas Filtri commitments to comply with Kyoto Treaty for the reduction of green house gas (CO<sub>2</sub>) emissions in the atmosphere.

### DISCHARGE KIT FOR -S- MODEL



brass discharge ball-valve with gasket



drain funnel



plastic hose-holder

In compliance with the European Standard UNI EN 1717/2002: designed to prevent back-flow contamination by making all elements downstream the discharge vent to atmosphere (protection unit symbol: DC)



-LUBRIKIT- single-dose lubricant for housing o-ring  
CODE RE9020650

### ACCESSORIES ON DEMAND

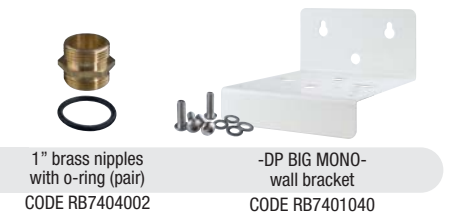

1" brass nipples with o-ring (pair)  
CODE RB7404002

-DP BIG MONO- wall bracket  
CODE RB7401040



-DP BIG DUO- wall bracket CODE RB7401043



-DP BIG TRIO- wall bracket CODE RB7401044



-KIT AUTO- for S models CODE RE7120024  
automatic discharge kit (see pages 186-187)



-KIT LEG 10- for DP BIG 10  
CODE RB7401051

-KIT LEG 20- for DP BIG 20  
CODE RB7401052



-KIT FRAME 10 MONO-  
for DP BIG 10 MONO  
CODE RB7401045

-KIT FRAME 20 MONO-  
for DP BIG 20 MONO  
CODE RB7401046



-KIT FRAME 10 DUO-  
for DP BIG 10 DUO  
CODE RB7401047

-KIT FRAME 20 DUO-  
for DP BIG 20 DUO  
CODE RB7401048



-KIT FRAME 10 TRIO-  
for DP BIG 10 TRIO  
CODE RB7401049

-KIT FRAME 20 TRIO-  
for DP BIG 20 TRIO  
CODE RB7401050



-VT- ground fixing kit CODE LB7221134



DP BIG FILTER HOUSINGS

DP BIG		10	MONO	1"	IN	TS
HOUSINGS MODEL		HOUSINGS HEIGHT	VERSION	IN / OUT	THREADS TYPE	BOWL TYPE
DP BIG	DP BIG M		MONO	1"	IN - PLASTIC BSP*	TS - CLEAR (PET)
DP BIG S	DP BIG S M		DUO	1 1/2"	NPT IN - PLASTIC NPT**	AB - BLUE (PP)
DP BIG PS PM			TRIO			

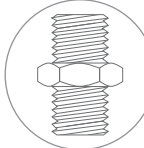

\* **BSP**  
parallel (cylindrical)  
ISO 228

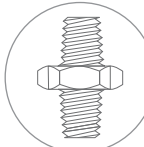

\*\* **NPT**  
tapered (conical)  
ANSI/ASME B1.20.1



# DP BIG MONO

## WORKING CONDITIONS

Max working pressure \_\_\_\_\_ 8,3 bar (120 psi)  
 Max working temperature \_\_\_\_\_ 45°C (113°F)  
 Min working temperature \_\_\_\_\_ 4°C (39,2°F)

## SPECIFICATIONS

Non-toxic materials, suitable for drinking water.  
 Head: reinforced polypropylene.  
 Clear bowl: PET.  
 Blue bowl: reinforced polypropylene.  
 O-ring: EPDM.  
 Breather-valve: body polypropylene, o-ring EPDM.

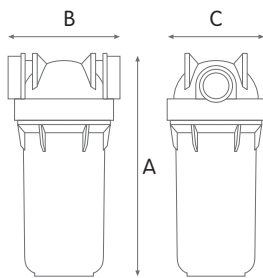

## DP BIG MONO clear housings

### HOUSINGS WITH PLASTIC BSP THREADS

CODE	MODEL	SUITABLE CARTRIDGE	IN/OUT	DIMENSIONS mm		
				A	B	C
RA1700711	DP BIG 10 MONO - 1" IN TS	10"	1"	360	190	185
RA1700911	DP BIG 10 MONO - 1"1/2 IN TS	10"	1"1/2	360	190	185
RA1800711	DP BIG 20 MONO - 1" IN TS	20"	1"	617	190	185
RA1800911	DP BIG 20 MONO - 1"1/2 IN TS	20"	1"1/2	617	190	185

### HOUSINGS WITH PLASTIC NPT THREADS

CODE	MODEL	SUITABLE CARTRIDGE	IN/OUT	DIMENSIONS mm		
				A	B	C
RA1700721	DP BIG 10 MONO - 1" NPT IN TS	10"	1"	360	190	185
RA1700921	DP BIG 10 MONO - 1"1/2 NPT IN TS	10"	1"1/2	360	190	185
RA1800721	DP BIG 20 MONO - 1" NPT IN TS	20"	1"	617	190	185
RA1800921	DP BIG 20 MONO - 1"1/2 NPT IN TS	20"	1"1/2	617	190	185



## DP BIG MONO blue housings

### HOUSINGS WITH PLASTIC BSP THREADS

CODE	MODEL	SUITABLE CARTRIDGE	IN/OUT	DIMENSIONS mm		
				A	B	C
RA1700712	DP BIG 10 MONO - 1" IN AB	10"	1"	360	190	185
RA1700912	DP BIG 10 MONO - 1"1/2 IN AB	10"	1"1/2	360	190	185
RA1800712	DP BIG 20 MONO - 1" IN AB	20"	1"	617	190	185
RA1800912	DP BIG 20 MONO - 1"1/2 IN AB	20"	1"1/2	617	190	185

### HOUSINGS WITH PLASTIC NPT THREADS

CODE	MODEL	SUITABLE CARTRIDGE	IN/OUT	DIMENSIONS mm		
				A	B	C
RA1700722	DP BIG 10 MONO - 1" NPT IN AB	10"	1"	360	190	185
RA1700922	DP BIG 10 MONO - 1"1/2 NPT IN AB	10"	1"1/2	360	190	185
RA1800722	DP BIG 20 MONO - 1" NPT IN AB	20"	1"	617	190	185
RA1800922	DP BIG 20 MONO - 1"1/2 NPT IN AB	20"	1"1/2	617	190	185



# DP BIG M MONO

## WORKING CONDITIONS

Max working pressure \_\_\_\_\_ 8,3 bar (120 psi)  
 Max working temperature \_\_\_\_\_ 45°C (113°F)  
 Min working temperature \_\_\_\_\_ 4°C (39,2°F)

## SPECIFICATIONS

Non-toxic materials, suitable for drinking water.  
 Head: reinforced polypropylene.  
 Clear bowl: PET.  
 Blue bowl: reinforced polypropylene.  
 O-ring: EPDM.  
 Breather-valve: body polypropylene, o-ring EPDM.  
 Manometers: radial type, pressure range 0-12 bar, 0-170 psi.

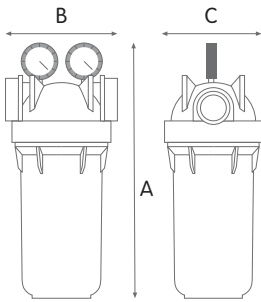

## DP BIG M MONO clear housings with 2 manometers

### HOUSINGS WITH PLASTIC BSP THREADS

CODE	MODEL	SUITABLE CARTRIDGE	IN/OUT	DIMENSIONS mm		
				A	B	C
RA1700731	DP BIG M 10 MONO - 1" IN TS	10"	1"	425	190	185
RA1700931	DP BIG M 10 MONO - 1"1/2 IN TS	10"	1"1/2	425	190	185
RA1800731	DP BIG M 20 MONO - 1" IN TS	20"	1"	682	190	185
RA1800931	DP BIG M 20 MONO - 1"1/2 IN TS	20"	1"1/2	682	190	185

DP BIG FILTER HOUSINGS



## DP BIG M MONO blue housings with 2 manometers

### HOUSINGS WITH PLASTIC BSP THREADS

CODE	MODEL	SUITABLE CARTRIDGE	IN/OUT	DIMENSIONS mm		
				A	B	C
RA1700732	DP BIG M 10 MONO - 1" IN AB	10"	1"	435	190	185
RA1700932	DP BIG M 10 MONO - 1"1/2 IN AB	10"	1"1/2	435	190	185
RA1800732	DP BIG M 20 MONO - 1" IN AB	20"	1"	682	190	185
RA1800932	DP BIG M 20 MONO - 1"1/2 IN AB	20"	1"1/2	682	190	185



# DP BIG S MONO

## WORKING CONDITIONS

Max working pressure \_\_\_\_\_ 8,3 bar (120 psi)  
 Max working temperature \_\_\_\_\_ 45°C (113°F)  
 Min working temperature \_\_\_\_\_ 4°C (39,2°F)

## SPECIFICATIONS

Non-toxic materials, suitable for drinking water.  
 Head: reinforced polypropylene.  
 Clear bowl: PET.  
 Blue bowl: reinforced polypropylene.  
 O-ring: EPDM.  
 Breather-valve: body polypropylene, o-ring EPDM.  
 Discharge ball-valve: CW 617 N brass nickel plated.  
 Drain funnel: reinforced polypropylene.

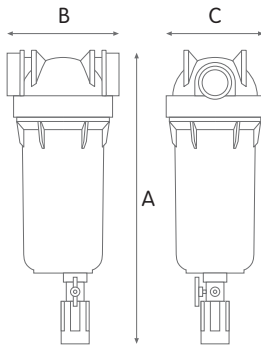

**DRAIN FUNNEL**  
 Back-flow preventing device  
 UNI EN 1717-11/2002

## DP BIG S MONO clear housings with discharge valve

### HOUSINGS WITH PLASTIC BSP THREADS

CODE	MODEL	SUITABLE CARTRIDGE	IN/OUT	DIMENSIONS mm		
				A	B	C
RA1700733	DP BIG S 10 MONO - 1" IN TS	10"	1"	480	190	185
RA1700933	DP BIG S 10 MONO - 1"1/2 IN TS	10"	1"1/2	480	190	185
RA1800733	DP BIG S 20 MONO - 1" IN TS	20"	1"	737	190	185
RA1800933	DP BIG S 20 MONO - 1"1/2 IN TS	20"	1"1/2	737	190	185



## DP BIG S MONO blue housings with discharge valve

### HOUSINGS WITH PLASTIC BSP THREADS

CODE	MODEL	SUITABLE CARTRIDGE	IN/OUT	DIMENSIONS mm		
				A	B	C
RA1700734	DP BIG S 10 MONO - 1" IN AB	10"	1"	480	190	185
RA1700934	DP BIG S 10 MONO - 1"1/2 IN AB	10"	1"1/2	480	190	185
RA1800734	DP BIG S 20 MONO - 1" IN AB	20"	1"	737	190	185
RA1800934	DP BIG S 20 MONO - 1"1/2 IN AB	20"	1"1/2	737	190	185





# DP BIG S M MONO

## WORKING CONDITIONS

Max working pressure \_\_\_\_\_ 8,3 bar (120 psi)  
 Max working temperature \_\_\_\_\_ 45°C (113°F)  
 Min working temperature \_\_\_\_\_ 4°C (39,2°F)

## SPECIFICATIONS

Non-toxic materials, suitable for drinking water.  
 Head: reinforced polypropylene.  
 Clear bowl: PET.  
 Blue bowl: reinforced polypropylene.  
 O-ring: EPDM.  
 Breather-valve: body polypropylene, o-ring EPDM.  
 Manometers: radial type, pressure range 0-12 bar, 0-170 psi.  
 Discharge ball-valve: CW 617 N brass nickel plated.  
 Drain funnel: reinforced polypropylene.

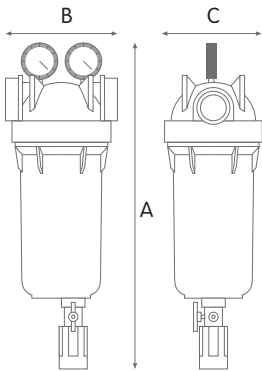

**DRAIN FUNNEL**  
 Back-flow preventing device  
 UNI EN 1717-11/2002

## DP BIG S M MONO clear housings with discharge valve and 2 manometers

### HOUSINGS WITH PLASTIC BSP THREADS

CODE	MODEL	SUITABLE CARTRIDGE	IN/OUT	DIMENSIONS mm		
				A	B	C
RA1700735	DP BIG S M 10 MONO - 1" IN TS	10"	1"	545	190	185
RA1700935	DP BIG S M 10 MONO - 1"1/2 IN TS	10"	1"1/2"	545	190	185
RA1800735	DP BIG S M 20 MONO - 1" IN TS	20"	1"	802	190	185
RA1800935	DP BIG S M 20 MONO - 1"1/2 IN TS	20"	1"1/2"	802	190	185



## DP BIG S M MONO blue housings with discharge valve and 2 manometers

### HOUSINGS WITH PLASTIC BSP THREADS

CODE	MODEL	SUITABLE CARTRIDGE	IN/OUT	DIMENSIONS mm		
				A	B	C
RA1700736	DP BIG S M 10 MONO - 1" IN AB	10"	1"	545	190	185
RA1700936	DP BIG S M 10 MONO - 1"1/2 IN AB	10"	1"1/2"	545	190	185
RA1800736	DP BIG S M 20 MONO - 1" IN AB	20"	1"	802	190	185
RA1800936	DP BIG S M 20 MONO - 1"1/2 IN AB	20"	1"1/2"	802	190	185



DP BIG FILTER HOUSINGS



# DP BIG PS PM MONO

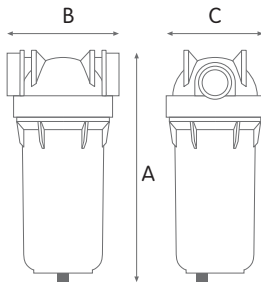

## WORKING CONDITIONS

Max working pressure \_\_\_\_\_ 8,3 bar (120 psi)  
 Max working temperature \_\_\_\_\_ 45°C (113°F)  
 Min working temperature \_\_\_\_\_ 4°C (39,2°F)

## SPECIFICATIONS

Non-toxic materials, suitable for drinking water.  
 Head: reinforced polypropylene.  
 Clear bowl: PET.  
 Blue bowl: reinforced polypropylene.  
 O-ring: EPDM.  
 Breather-valve: body polypropylene, o-ring EPDM.  
 Drain plug: nylon.  
 Manometer plug: CW 614 N brass.

DRAIN PLUG

MANOMETER PLUG



## DP BIG PS PM MONO clear housings with drain and manometer plugs

### HOUSINGS WITH PLASTIC BSP THREADS

CODE	MODEL	SUITABLE CARTRIDGE	IN/OUT	DIMENSIONS mm		
				A	B	C
RA1701735	DP BIG PS PM 10 MONO - 1" IN TS	10"	1"	390	190	185
RA1701935	DP BIG PS PM 10 MONO - 1"1/2 IN TS	10"	1"1/2	390	190	185
RA1801735	DP BIG PS PM 20 MONO - 1" IN TS	20"	1"	647	190	185
RA1801935	DP BIG PS PM 20 MONO - 1"1/2 IN TS	20"	1"1/2	647	190	185

### HOUSINGS WITH PLASTIC NPT THREADS

CODE	MODEL	SUITABLE CARTRIDGE	IN/OUT	DIMENSIONS mm		
				A	B	C
RA1701745	DP BIG PS PM 10 MONO - 1" NPT IN TS	10"	1"	390	190	185
RA1701945	DP BIG PS PM 10 MONO - 1"1/2 NPT IN TS	10"	1"1/2	390	190	185
RA1801745	DP BIG PS PM 20 MONO - 1" NPT IN TS	20"	1"	647	190	185
RA1801945	DP BIG PS PM 20 MONO - 1"1/2 NPT IN TS	20"	1"1/2	647	190	185



## DP BIG PS PM MONO blue housings with drain and manometer plugs

### HOUSINGS WITH PLASTIC BSP THREADS

CODE	MODEL	SUITABLE CARTRIDGE	IN/OUT	DIMENSIONS mm		
				A	B	C
RA1701736	DP BIG PS PM 10 MONO - 1" IN AB	10"	1"	390	190	185
RA1701936	DP BIG PS PM 10 MONO - 1"1/2 IN AB	10"	1"1/2	390	190	185
RA1801736	DP BIG PS PM 20 MONO - 1" IN AB	20"	1"	647	190	185
RA1801936	DP BIG PS PM 20 MONO - 1"1/2 IN AB	20"	1"1/2	647	190	185

### HOUSINGS WITH PLASTIC NPT THREADS

CODE	MODEL	SUITABLE CARTRIDGE	IN/OUT	DIMENSIONS mm		
				A	B	C
RA1701746	DP BIG PS PM 10 MONO - 1" NPT IN AB	10"	1"	390	190	185
RA1701946	DP BIG PS PM 10 MONO - 1"1/2 NPT IN AB	10"	1"1/2	390	190	185
RA1801746	DP BIG PS PM 20 MONO - 1" NPT IN AB	20"	1"	647	190	185
RA1801946	DP BIG PS PM 20 MONO - 1"1/2 NPT IN AB	20"	1"1/2	647	190	185







# DP BIG DUO

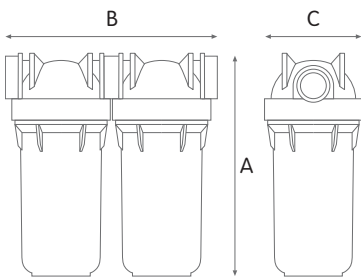

## WORKING CONDITIONS

Max working pressure \_\_\_\_\_ 8,3 bar (120 psi)  
 Max working temperature \_\_\_\_\_ 45°C (113°F)  
 Min working temperature \_\_\_\_\_ 4°C (39,2°F)

## SPECIFICATIONS

Non-toxic materials, suitable for drinking water.  
 Head: reinforced polypropylene.  
 Clear bowl: PET.  
 Blue bowl: reinforced polypropylene.  
 O-ring: EPDM.  
 Breather-valve: body polypropylene, o-ring EPDM.



## DP BIG DUO clear housings

### HOUSINGS WITH PLASTIC BSP THREADS

CODE	MODEL	SUITABLE CARTRIDGE	IN/OUT	DIMENSIONS mm		
				A	B	C
RA1702711	DP BIG 10 DUO - 1" IN TS	10"	1"	375	390	185
RA1702911	DP BIG 10 DUO - 1"1/2 IN TS	10"	1"1/2	375	390	185
RA1802711	DP BIG 20 DUO - 1" IN TS	20"	1"	640	390	185
RA1802911	DP BIG 20 DUO - 1"1/2 IN TS	20"	1"1/2	640	390	185

### HOUSINGS WITH PLASTIC NPT THREADS

CODE	MODEL	SUITABLE CARTRIDGE	IN/OUT	DIMENSIONS mm		
				A	B	C
RA1702721	DP BIG 10 DUO - 1" NPT IN TS	10"	1"	375	390	185
RA1702921	DP BIG 10 DUO - 1"1/2 NPT IN TS	10"	1"1/2	375	390	185
RA1802721	DP BIG 20 DUO - 1" NPT IN TS	20"	1"	640	390	185
RA1802921	DP BIG 20 DUO - 1"1/2 NPT IN TS	20"	1"1/2	640	390	185



## DP BIG DUO blue housings

### HOUSINGS WITH PLASTIC BSP THREADS

CODE	MODEL	SUITABLE CARTRIDGE	IN/OUT	DIMENSIONS mm		
				A	B	C
RA1702712	DP BIG 10 DUO - 1" IN AB	10"	1"	375	390	185
RA1702912	DP BIG 10 DUO - 1"1/2 IN AB	10"	1"1/2	375	390	185
RA1802712	DP BIG 20 DUO - 1" IN AB	20"	1"	640	390	185
RA1802912	DP BIG 20 DUO - 1"1/2 IN AB	20"	1"1/2	640	390	185

### HOUSINGS WITH PLASTIC NPT THREADS

CODE	MODEL	SUITABLE CARTRIDGE	IN/OUT	DIMENSIONS mm		
				A	B	C
RA1702722	DP BIG 10 DUO - 1" NPT IN AB	10"	1"	375	390	185
RA1702922	DP BIG 10 DUO - 1"1/2 NPT IN AB	10"	1"1/2	375	390	185
RA1802722	DP BIG 20 DUO - 1" NPT IN AB	20"	1"	640	390	185
RA1802922	DP BIG 20 DUO - 1"1/2 NPT IN AB	20"	1"1/2	640	390	185



# DP BIG M DUO

## WORKING CONDITIONS

Max working pressure \_\_\_\_\_ 8,3 bar (120 psi)  
 Max working temperature \_\_\_\_\_ 45°C (113°F)  
 Min working temperature \_\_\_\_\_ 4°C (39,2°F)

## SPECIFICATIONS

Non-toxic materials, suitable for drinking water.  
 Head: reinforced polypropylene.  
 Clear bowl: PET.  
 Blue bowl: reinforced polypropylene.  
 O-ring: EPDM.  
 Breather-valve: body polypropylene, o-ring EPDM.  
 Manometers: radial type, pressure range 0-12 bar, 0-170 psi.

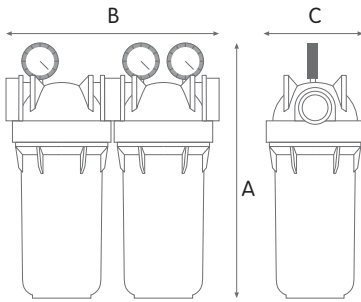

DP BIG M DUO clear housings with 3 manometers

### HOUSINGS WITH PLASTIC BSP THREADS

CODE	MODEL	SUITABLE CARTRIDGE	IN/OUT	DIMENSIONS mm		
				A	B	C
RA1702731	DP BIG M 10 DUO - 1" IN TS	10"	1"	440	390	185
RA1702931	DP BIG M 10 DUO - 1"1/2 IN TS	10"	1"1/2	440	390	185
RA1802731	DP BIG M 20 DUO - 1" IN TS	20"	1"	705	390	185
RA1802931	DP BIG M 20 DUO - 1"1/2 IN TS	20"	1"1/2	705	390	185



DP BIG M DUO blue housings with 3 manometers

### HOUSINGS WITH PLASTIC BSP THREADS

CODE	MODEL	SUITABLE CARTRIDGE	IN/OUT	DIMENSIONS mm		
				A	B	C
RA1702732	DP BIG M 10 DUO - 1" IN AB	10"	1"	440	390	185
RA1702932	DP BIG M 10 DUO - 1"1/2 IN AB	10"	1"1/2	440	390	185
RA1802732	DP BIG M 20 DUO - 1" IN AB	20"	1"	705	390	185
RA1802932	DP BIG M 20 DUO - 1"1/2 IN AB	20"	1"1/2	705	390	185



# DP BIG S DUO

## WORKING CONDITIONS

Max working pressure \_\_\_\_\_ 8,3 bar (120 psi)  
 Max working temperature \_\_\_\_\_ 45°C (113°F)  
 Min working temperature \_\_\_\_\_ 4°C (39,2°F)

## SPECIFICATIONS

Non-toxic materials, suitable for drinking water.  
 Head: reinforced polypropylene.  
 Clear bowl: PET.  
 Blue bowl: reinforced polypropylene.  
 O-ring: EPDM.  
 Breather-valve: body polypropylene, o-ring EPDM.  
 Discharge ball-valve: CW 617 N brass nickel plated.  
 Drain funnel: reinforced polypropylene.

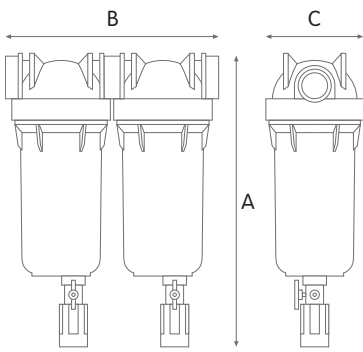

**DRAIN FUNNEL**  
 Back-flow preventing device  
 UNI EN 1717-11/2002

## DP BIG S DUO clear housings with discharge valves

### HOUSINGS WITH PLASTIC BSP THREADS

CODE	MODEL	SUITABLE CARTRIDGE	IN/OUT	DIMENSIONS mm		
				A	B	C
RA1702733	DP BIG S 10 DUO - 1" IN TS	10"	1"	495	390	185
RA1702933	DP BIG S 10 DUO - 1"1/2 IN TS	10"	1"1/2	495	390	185
RA1802733	DP BIG S 20 DUO - 1" IN TS	20"	1"	760	390	185
RA1802933	DP BIG S 20 DUO - 1"1/2 IN TS	20"	1"1/2	760	390	185



## DP BIG S DUO blue housings with discharge valves

### HOUSINGS WITH PLASTIC BSP THREADS

CODE	MODEL	SUITABLE CARTRIDGE	IN/OUT	DIMENSIONS mm		
				A	B	C
RA1702734	DP BIG S 10 DUO - 1" IN AB	10"	1"	495	390	185
RA1702934	DP BIG S 10 DUO - 1"1/2 IN AB	10"	1"1/2	495	390	185
RA1802734	DP BIG S 20 DUO - 1" IN AB	20"	1"	760	390	185
RA1802934	DP BIG S 20 DUO - 1"1/2 IN AB	20"	1"1/2	760	390	185



DP BIG FILTER HOUSINGS



# DP BIG S M DUO

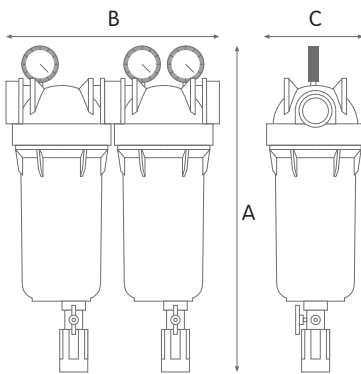

## WORKING CONDITIONS

Max working pressure \_\_\_\_\_ 8,3 bar (120 psi)  
 Max working temperature \_\_\_\_\_ 45°C (113°F)  
 Min working temperature \_\_\_\_\_ 4°C (39,2°F)

## SPECIFICATIONS

Non-toxic materials, suitable for drinking water.  
 Head: reinforced polypropylene.  
 Clear bowl: PET.  
 Blue bowl: reinforced polypropylene.  
 O-ring: EPDM.  
 Breather-valve: body polypropylene, o-ring EPDM.  
 Manometers: radial type, pressure range 0-12 bar, 0-170 psi.  
 Discharge ball-valve: CW 617 N brass nickel plated.  
 Drain funnel: reinforced polypropylene.



**DRAIN FUNNEL**  
 Back-flow preventing device  
 UNI EN 1717-11/2002

## DP BIG S M DUO clear housings with discharge valves and 3 manometers



### HOUSINGS WITH PLASTIC BSP THREADS

CODE	MODEL	SUITABLE CARTRIDGE	IN/OUT	DIMENSIONS mm		
				A	B	C
RA1702735	DP BIG S M 10 DUO - 1" IN TS	10"	1"	560	390	185
RA1702935	DP BIG S M 10 DUO - 1"1/2 IN TS	10"	1"1/2	560	390	185
RA1802735	DP BIG S M 20 DUO - 1" IN TS	20"	1"	825	390	185
RA1802935	DP BIG S M 20 DUO - 1"1/2 IN TS	20"	1"1/2	825	390	185

## DP BIG S M DUO blue housings with discharge valves and 3 manometers



### HOUSINGS WITH PLASTIC BSP THREADS

CODE	MODEL	SUITABLE CARTRIDGE	IN/OUT	DIMENSIONS mm		
				A	B	C
RA1702736	DP BIG S M 10 DUO - 1" IN AB	10"	1"	560	390	185
RA1702936	DP BIG S M 10 DUO - 1"1/2 IN AB	10"	1"1/2	560	390	185
RA1802736	DP BIG S M 20 DUO - 1" IN AB	20"	1"	825	390	185
RA1802936	DP BIG S M 20 DUO - 1"1/2 IN AB	20"	1"1/2	825	390	185



# DP BIG PS PM DUO

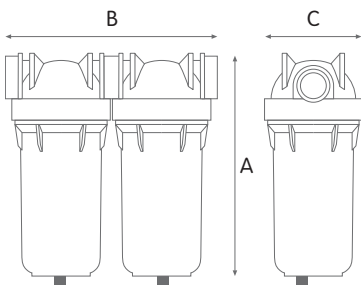

### WORKING CONDITIONS

Max working pressure \_\_\_\_\_ 8,3 bar (120 psi)  
 Max working temperature \_\_\_\_\_ 45°C (113°F)  
 Min working temperature \_\_\_\_\_ 4°C (39,2°F)

### SPECIFICATIONS

Non-toxic materials, suitable for drinking water.  
 Head: reinforced polypropylene.  
 Clear bowl: PET.  
 Blue bowl: reinforced polypropylene.  
 O-ring: EPDM.  
 Breather-valve: body polypropylene, o-ring EPDM.  
 Drain plug: nylon.  
 Manometer plug: CW 614 N brass.

DRAIN PLUG

MANOMETER PLUG



## DP BIG PS PM DUO clear housings with drain and manometer plugs

### HOUSINGS WITH PLASTIC BSP THREADS

CODE	MODEL	SUITABLE CARTRIDGE	IN/OUT	DIMENSIONS mm		
				A	B	C
RA1702765	DP BIG PS PM 10 DUO - 1" IN TS	10"	1"	405	390	185
RA1702965	DP BIG PS PM 10 DUO - 1"1/2 IN TS	10"	1"1/2	405	390	185
RA1802765	DP BIG PS PM 20 DUO - 1" IN TS	20"	1"	670	390	185
RA1802965	DP BIG PS PM 20 DUO - 1"1/2 IN TS	20"	1"1/2	670	390	185

### HOUSINGS WITH PLASTIC NPT THREADS

CODE	MODEL	SUITABLE CARTRIDGE	IN/OUT	DIMENSIONS mm		
				A	B	C
RA1702755	DP BIG PS PM 10 DUO - 1" NPT IN TS	10"	1"	405	390	185
RA1702955	DP BIG PS PM 10 DUO - 1"1/2 NPT IN TS	10"	1"1/2	405	390	185
RA1802755	DP BIG PS PM 20 DUO - 1" NPT IN TS	20"	1"	670	390	185
RA1802955	DP BIG PS PM 20 DUO - 1"1/2 NPT IN TS	20"	1"1/2	670	390	185



## DP BIG PS PM DUO blue housings with drain and manometer plugs

### HOUSINGS WITH PLASTIC BSP THREADS

CODE	MODEL	SUITABLE CARTRIDGE	IN/OUT	DIMENSIONS mm		
				A	B	C
RA1702766	DP BIG PS PM 10 DUO - 1" IN AB	10"	1"	405	390	185
RA1702966	DP BIG PS PM 10 DUO - 1"1/2 IN AB	10"	1"1/2	405	390	185
RA1802766	DP BIG PS PM 20 DUO - 1" IN AB	20"	1"	670	390	185
RA1802966	DP BIG PS PM 20 DUO - 1"1/2 IN AB	20"	1"1/2	670	390	185

### HOUSINGS WITH PLASTIC NPT THREADS

CODE	MODEL	SUITABLE CARTRIDGE	IN/OUT	DIMENSIONS mm		
				A	B	C
RA1702756	DP BIG PS PM 10 DUO - 1" NPT IN AB	10"	1"	405	390	185
RA1702956	DP BIG PS PM 10 DUO - 1"1/2 NPT IN AB	10"	1"1/2	405	390	185
RA1802756	DP BIG PS PM 20 DUO - 1" NPT IN AB	20"	1"	670	390	185
RA1802956	DP BIG PS PM 20 DUO - 1"1/2 NPT IN AB	20"	1"1/2	670	390	185





# DP BIG TRIO

## WORKING CONDITIONS

Max working pressure \_\_\_\_\_ 8,3 bar (120 psi)  
 Max working temperature \_\_\_\_\_ 45°C (113°F)  
 Min working temperature \_\_\_\_\_ 4°C (39,2°F)

## SPECIFICATIONS

Non-toxic materials, suitable for drinking water.  
 Head: reinforced polypropylene.  
 Clear bowl: PET.  
 Blue bowl: reinforced polypropylene.  
 O-ring: EPDM.  
 Breather-valve: body polypropylene, o-ring EPDM.

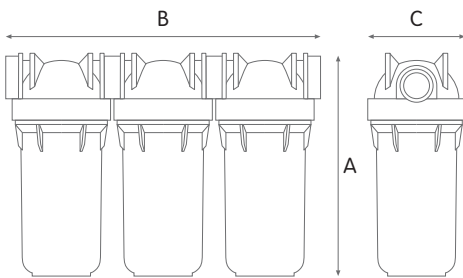

## DP BIG TRIO clear housings

### HOUSINGS WITH PLASTIC BSP THREADS

CODE	MODEL	SUITABLE CARTRIDGE	IN/OUT	DIMENSIONS mm		
				A	B	C
RA1703711	DP BIG 10 TRIO - 1" IN TS	10"	1"	375	590	185
RA1703911	DP BIG 10 TRIO - 1"1/2 IN TS	10"	1"1/2	375	590	185
RA1803711	DP BIG 20 TRIO - 1" IN TS	20"	1"	640	590	185
RA1803911	DP BIG 20 TRIO - 1"1/2 IN TS	20"	1"1/2	640	590	185

### HOUSINGS WITH PLASTIC NPT THREADS

CODE	MODEL	SUITABLE CARTRIDGE	IN/OUT	DIMENSIONS mm		
				A	B	C
RA1703721	DP BIG 10 TRIO - 1" NPT IN TS	10"	1"	375	590	185
RA1703921	DP BIG 10 TRIO - 1"1/2 NPT IN TS	10"	1"1/2	375	590	185
RA1803721	DP BIG 20 TRIO - 1" NPT IN TS	20"	1"	640	590	185
RA1803921	DP BIG 20 TRIO - 1"1/2 NPT IN TS	20"	1"1/2	640	590	185

## DP BIG TRIO blue housings

### HOUSINGS WITH PLASTIC BSP THREADS

CODE	MODEL	SUITABLE CARTRIDGE	IN/OUT	DIMENSIONS mm		
				A	B	C
RA1703712	DP BIG 10 TRIO - 1" IN AB	10"	1"	375	590	185
RA1703912	DP BIG 10 TRIO - 1"1/2 IN AB	10"	1"1/2	375	590	185
RA1803712	DP BIG 20 TRIO - 1" IN AB	20"	1"	640	590	185
RA1803912	DP BIG 20 TRIO - 1"1/2 IN AB	20"	1"1/2	640	590	185

### HOUSINGS WITH PLASTIC NPT THREADS

CODE	MODEL	SUITABLE CARTRIDGE	IN/OUT	DIMENSIONS mm		
				A	B	C
RA1703722	DP BIG 10 TRIO - 1" NPT IN AB	10"	1"	375	590	185
RA1703922	DP BIG 10 TRIO - 1"1/2 NPT IN AB	10"	1"1/2	375	590	185
RA1803722	DP BIG 20 TRIO - 1" NPT IN AB	20"	1"	640	590	185
RA1803922	DP BIG 20 TRIO - 1"1/2 NPT IN AB	20"	1"1/2	640	590	185





# DP BIG M TRIO

## WORKING CONDITIONS

Max working pressure \_\_\_\_\_ 8,3 bar (120 psi)  
 Max working temperature \_\_\_\_\_ 45°C (113°F)  
 Min working temperature \_\_\_\_\_ 4°C (39,2°F)

## SPECIFICATIONS

Non-toxic materials, suitable for drinking water.  
 Head: reinforced polypropylene.  
 Clear bowl: PET.  
 Blue bowl: reinforced polypropylene.  
 O-ring: EPDM.  
 Breather-valve: body polypropylene, o-ring EPDM.  
 Manometers: radial type, pressure range 0-12 bar, 0-170 psi.

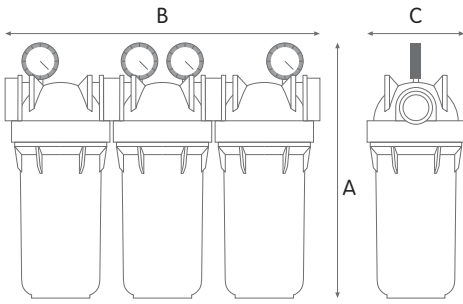

## DP BIG M TRIO clear housings with 4 manometers

### HOUSINGS WITH PLASTIC BSP THREADS

CODE	MODEL	SUITABLE CARTRIDGE	IN/OUT	DIMENSIONS mm		
				A	B	C
RA1703731	DP BIG M 10 TRIO - 1" IN TS	10"	1"	440	590	185
RA1703931	DP BIG M 10 TRIO - 1 1/2 IN TS	10"	1 1/2"	440	590	185
RA1803731	DP BIG M 20 TRIO - 1" IN TS	20"	1"	705	590	185
RA1803931	DP BIG M 20 TRIO - 1 1/2 IN TS	20"	1 1/2"	705	590	185



## DP BIG M TRIO blue housings with 4 manometers

### HOUSINGS WITH PLASTIC BSP THREADS

CODE	MODEL	SUITABLE CARTRIDGE	IN/OUT	DIMENSIONS mm		
				A	B	C
RA1703732	DP BIG M 10 TRIO - 1" IN AB	10"	1"	440	590	185
RA1703932	DP BIG M 10 TRIO - 1 1/2 IN AB	10"	1 1/2"	440	590	185
RA1803732	DP BIG M 20 TRIO - 1" IN AB	20"	1"	705	590	185
RA1803932	DP BIG M 20 TRIO - 1 1/2 IN AB	20"	1 1/2"	705	590	185



DP BIG FILTER HOUSINGS



# DP BIG S TRIO

## WORKING CONDITIONS

Max working pressure \_\_\_\_\_ 8,3 bar (120 psi)  
 Max working temperature \_\_\_\_\_ 45°C (113°F)  
 Min working temperature \_\_\_\_\_ 4°C (39,2°F)

## SPECIFICATIONS

Non-toxic materials, suitable for drinking water.  
 Head: reinforced polypropylene.  
 Clear bowl: PET.  
 Blue bowl: reinforced polypropylene.  
 O-ring: EPDM.  
 Breather-valve: body polypropylene, o-ring EPDM.  
 Discharge ball-valve: CW 617 N brass nickel plated.  
 Drain funnel: reinforced polypropylene.

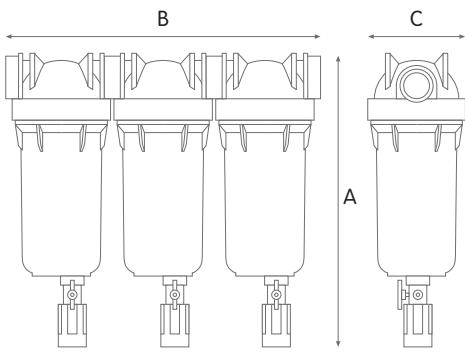

**DRAIN FUNNEL**  
 Back-flow preventing device  
 UNI EN 1717-11/2002

## DP BIG S TRIO clear housings with discharge valves

### HOUSINGS WITH PLASTIC BSP THREADS

CODE	MODEL	SUITABLE CARTRIDGE	IN/OUT	DIMENSIONS mm		
				A	B	C
RA1703733	DP BIG S 10 TRIO - 1" IN TS	10"	1"	495	590	185
RA1703933	DP BIG S 10 TRIO - 1"1/2 IN TS	10"	1"1/2	495	590	185
RA1803733	DP BIG S 20 TRIO - 1" IN TS	20"	1"	760	590	185
RA1803933	DP BIG S 20 TRIO - 1"1/2 IN TS	20"	1"1/2	760	590	185



## DP BIG S TRIO blue housings with discharge valves

### HOUSINGS WITH PLASTIC BSP THREADS

CODE	MODEL	SUITABLE CARTRIDGE	IN/OUT	DIMENSIONS mm		
				A	B	C
RA1703734	DP BIG S 10 TRIO - 1" IN AB	10"	1"	495	590	185
RA1703934	DP BIG S 10 TRIO - 1"1/2 IN AB	10"	1"1/2	495	590	185
RA1803734	DP BIG S 20 TRIO - 1" IN AB	20"	1"	760	590	185
RA1803934	DP BIG S 20 TRIO - 1"1/2 IN AB	20"	1"1/2	760	590	185







# DP BIG S M TRIO

## WORKING CONDITIONS

Max working pressure \_\_\_\_\_ 8,3 bar (120 psi)  
 Max working temperature \_\_\_\_\_ 45°C (113°F)  
 Min working temperature \_\_\_\_\_ 4°C (39,2°F)

## SPECIFICATIONS

Non-toxic materials, suitable for drinking water.  
 Head: reinforced polypropylene.  
 Clear bowl: PET.  
 Blue bowl: reinforced polypropylene.  
 O-ring: EPDM.  
 Breather-valve: body polypropylene, o-ring EPDM.  
 Manometers: radial type, pressure range 0-12 bar, 0-170 psi.  
 Discharge ball-valve: CW 617 N brass nickel plated.  
 Drain funnel: reinforced polypropylene.



**DRAIN FUNNEL**  
 Back-flow preventing device  
 UNI EN 1717-11/2002

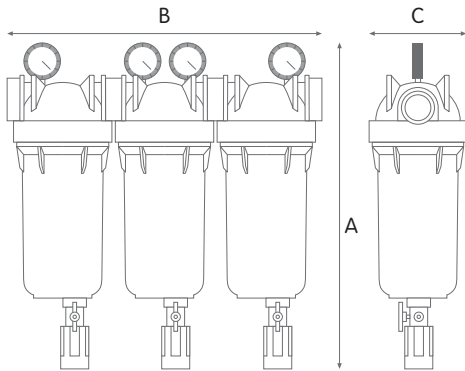

## DP BIG S M TRIO clear housings with discharge valves and 4 manometers

### HOUSINGS WITH PLASTIC BSP THREADS

CODE	MODEL	SUITABLE CARTRIDGE	IN/OUT	DIMENSIONS mm		
				A	B	C
RA1703735	DP BIG S M 10 TRIO - 1" IN TS	10"	1"	560	590	185
RA1703935	DP BIG S M 10 TRIO - 1"1/2 IN TS	10"	1"1/2"	560	590	185
RA1803735	DP BIG S M 20 TRIO - 1" IN TS	20"	1"	825	590	185
RA1803935	DP BIG S M 20 TRIO - 1"1/2 IN TS	20"	1"1/2"	825	590	185



## DP BIG S M TRIO blue housings with discharge valves and 4 manometers

### HOUSINGS WITH PLASTIC BSP THREADS

CODE	MODEL	SUITABLE CARTRIDGE	IN/OUT	DIMENSIONS mm		
				A	B	C
RA1703736	DP BIG S M 10 TRIO - 1" IN AB	10"	1"	560	590	185
RA1703936	DP BIG S M 10 TRIO - 1"1/2 IN AB	10"	1"1/2"	560	590	185
RA1803736	DP BIG S M 20 TRIO - 1" IN AB	20"	1"	825	590	185
RA1803936	DP BIG S M 20 TRIO - 1"1/2 IN AB	20"	1"1/2"	825	590	185



DP BIG FILTER HOUSINGS



# DP BIG PS PM TRIO

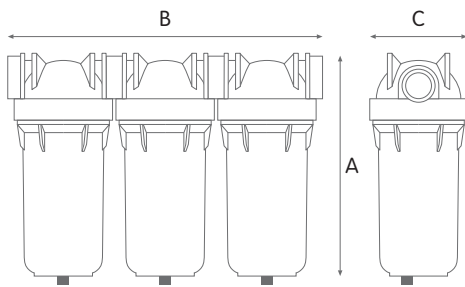

## WORKING CONDITIONS

Max working pressure \_\_\_\_\_ 8,3 bar (120 psi)  
 Max working temperature \_\_\_\_\_ 45°C (113°F)  
 Min working temperature \_\_\_\_\_ 4°C (39,2°F)

## SPECIFICATIONS

Non-toxic materials, suitable for drinking water.  
 Head: reinforced polypropylene.  
 Clear bowl: PET.  
 Blue bowl: reinforced polypropylene.  
 O-ring: EPDM.  
 Breather-valve: body polypropylene, o-ring EPDM.  
 Drain plug: nylon.  
 Manometer plug: CW 614 N brass.

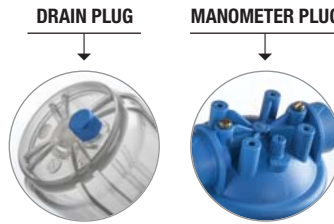

## DP BIG PS PM TRIO clear housings with drain and manometer plugs

### HOUSINGS WITH PLASTIC BSP THREADS

CODE	MODEL	SUITABLE CARTRIDGE	IN/OUT	DIMENSIONS mm		
				A	B	C
RA1703765	DP BIG PS PM 10 TRIO - 1" IN TS	10"	1"	405	590	185
RA1703965	DP BIG PS PM 10 TRIO - 1"1/2 IN TS	10"	1"1/2"	405	590	185
RA1803765	DP BIG PS PM 20 TRIO - 1" IN TS	20"	1"	670	590	185
RA1803965	DP BIG PS PM 20 TRIO - 1"1/2 IN TS	20"	1"1/2"	670	590	185

### HOUSINGS WITH PLASTIC NPT THREADS

CODE	MODEL	SUITABLE CARTRIDGE	IN/OUT	DIMENSIONS mm		
				A	B	C
RA1703755	DP BIG PS PM 10 TRIO - 1" NPT IN TS	10"	1"	405	590	185
RA1703955	DP BIG PS PM 10 TRIO - 1"1/2 NPT IN TS	10"	1"1/2"	405	590	185
RA1803755	DP BIG PS PM 20 TRIO - 1" NPT IN TS	20"	1"	670	590	185
RA1803955	DP BIG PS PM 20 TRIO - 1"1/2 NPT IN TS	20"	1"1/2"	670	590	185



## DP BIG PS PM TRIO blue housings with drain and manometer plugs

### HOUSINGS WITH PLASTIC BSP THREADS

CODE	MODEL	SUITABLE CARTRIDGE	IN/OUT	DIMENSIONS mm		
				A	B	C
RA1703766	DP BIG PS PM 10 TRIO - 1" IN AB	10"	1"	405	590	185
RA1703966	DP BIG PS PM 10 TRIO - 1"1/2 IN AB	10"	1"1/2"	405	590	185
RA1803766	DP BIG PS PM 20 TRIO - 1" IN AB	20"	1"	670	590	185
RA1803966	DP BIG PS PM 20 TRIO - 1"1/2 IN AB	20"	1"1/2"	670	590	185

### HOUSINGS WITH PLASTIC NPT THREADS

CODE	MODEL	SUITABLE CARTRIDGE	IN/OUT	DIMENSIONS mm		
				A	B	C
RA1703756	DP BIG PS PM 10 TRIO - 1" NPT IN AB	10"	1"	405	590	185
RA1703956	DP BIG PS PM 10 TRIO - 1"1/2 NPT IN AB	10"	1"1/2"	405	590	185
RA1803756	DP BIG PS PM 20 TRIO - 1" NPT IN AB	20"	1"	670	590	185
RA1803956	DP BIG PS PM 20 TRIO - 1"1/2 NPT IN AB	20"	1"1/2"	670	590	185

